



MIL-DTL-38999 Series I

MIL-DTL-38999 series I circular connector is designed for quick bayonet coupling, solder contact and removable crimp contact, excellent environmental resistance performance, EMI/RFI shielding, high contact density, small size, light weight, withstand vibration and scoop-proof, mating hermetic.

This family of circular connectors is offered 3 kinds shell of different material, 9 kinds of size shell, 3 kinds of finishes, 5 receptacle-mounting styles, 5 kinds of contact and more than 60 kinds contact layout.



Part number

Basic series	RF	27466	E	19	B	35	P	N
Type of shell								
27467 = Straight plug								
27466 = Wall mounting square receptacle, front								
27656 = Wall mounting square receptacle, rear								
27496 = Box square receptacle, front								
27505 = Box square receptacle, rear								
27468 = Jam nut receptacle								
Shell								
T = With thread and accessory								
E = Without thread or accessory								
Shell size								
09, 11, 13, 15, 17, 19, 21, 23, 25								
Finish								
B = Olive green cadmium plating								
C = Black anodized								
E = Passivated stainless steel								
F = Bright electroless nickel plating								
Contact layout (See below)								
Type of contact								
P = Crimp pin								
S = Crimp socket								
PH = Solder pin								
SH = Solder socket								
PL = Long PCB pin								
PC = Short PCB pin								
SL = Long PCB socket								
SC = Short PCB socket								
Orientation								
N = Normal								
A, B, C, D = Alternative								

Electrical

Contact resistance and current rating:

Contact No.	Diameter (mm)	Resistance (mΩ)	Current (A)
22D*	Φ0.76	≤12.0	5.0
20*	Φ1.00	≤5.0	7.5
16*	Φ1.60	≤2.5	13.0
12*	Φ2.40	≤1.5	23.0
10*	Φ3.15	≤1.0	40.0

EMI shielding:

100MHz~1GHz: minimum attenuation 85dB

1GHz~10GHz: minimum attenuation 50dB

Withstanding voltage (V):

Service rating	M	N	I	II
Sea level	1300	1000	1800	2300
21000m	800	600	1000	1000

Insulation resistance:

Normal ≥ 5000MΩ, damp heat ≥ 100MΩ

Electrical continuity between shells:

Class B ≤ 2.5mΩ, class F ≤ 1.0mΩ, class E ≤ 5.0mΩ

Mechanical

Shell material:

Aluminium alloy, stainless steel or copper-alloy

Plating:

Class B: Olive green cadmium plating Class E: Passivated stainless steel

Class C: Anodize Class F: Electroless nickel plating

Insulator:

Thermo-set plastic or PBT

Grommet and seal:

Silicon rubber

Contact:

Copper alloy gold plating, crimp or PCB

Endurance:

500 cycles

Vibration:

Sinusoid vibration: frequency: 10~2000Hz, acceleration: 294m/s²

Random vibration: at frequency: 100~1000Hz, density of power chart: 1G²/Hz

Shock:

At 3 ms half sinusoid, peak value of acceleration: 300g

Environmental

Operating temperature:

Class B: -65°C ~ +175°C

Class C, E, F: -65°C ~ +200°C

Salt spray:

Class B, E: 500h

Class F: 48h

Relative humidity: 98% at 40°C

Operating height: ≤ 30480m

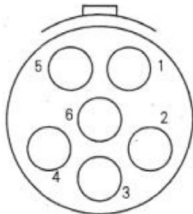
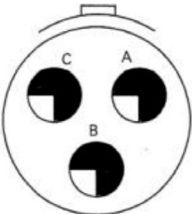
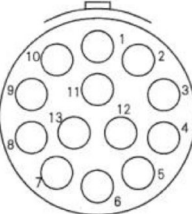
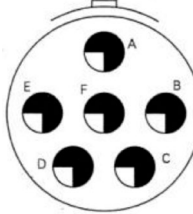
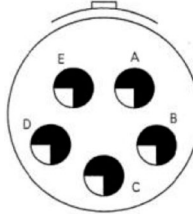
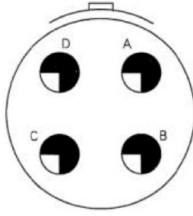
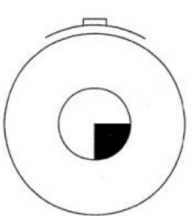
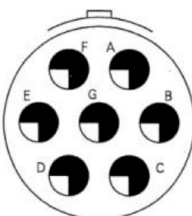
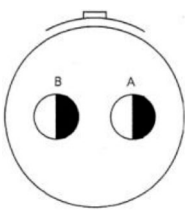
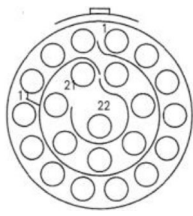
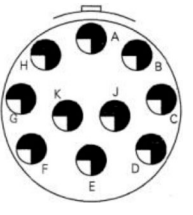
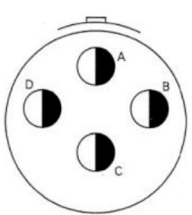
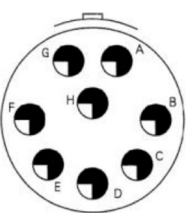
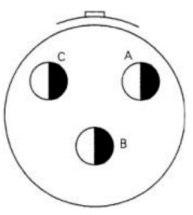
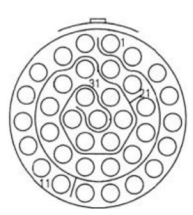
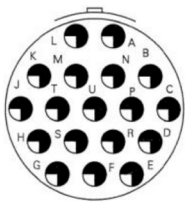
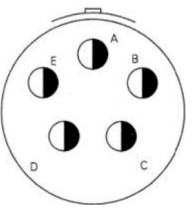
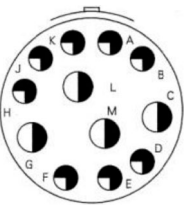
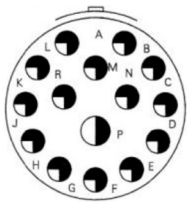
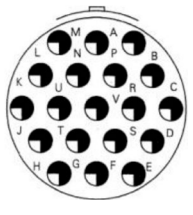
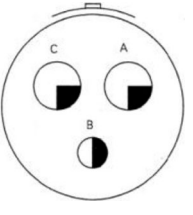
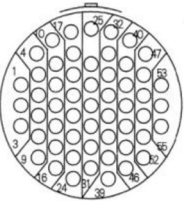
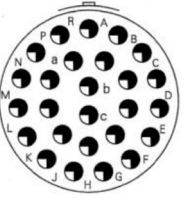
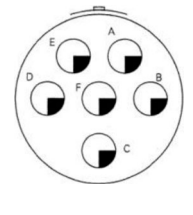
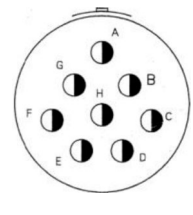

Contact layout

 <p>09-35 M</p>	 <p>09-98 I</p>	 <p>11-35 M</p>	 <p>11-98 I</p>	 <p>11-05 I</p>
 <p>11-04 I</p>	 <p>11-01 I</p>	 <p>11-99 I</p>	 <p>11-02 I</p>	 <p>13-35 M</p>
 <p>13-98 I</p>	 <p>13-04 I</p>	 <p>13-08 I</p>	 <p>13-03 II</p>	 <p>15-35 M</p>
 <p>15-18 I</p>	 <p>15-05 II</p>	 <p>15-97 I</p>	 <p>15-15 I</p>	 <p>15-19 I</p>
 <p>15-03 II</p>	 <p>17-35 M</p>	 <p>17-26 I</p>	 <p>17-06 I</p>	 <p>17-08 II</p>

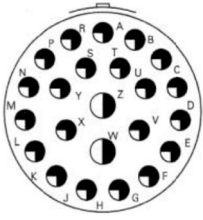
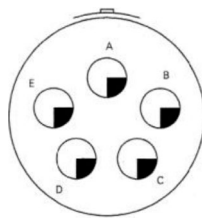
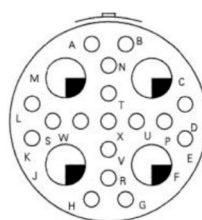
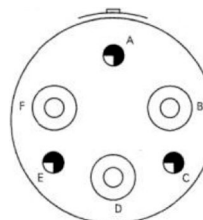
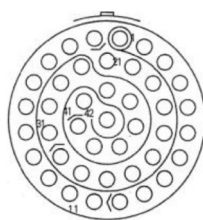
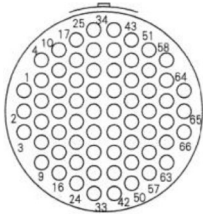
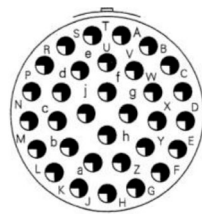
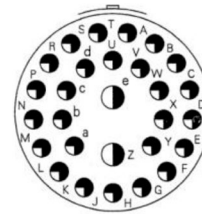
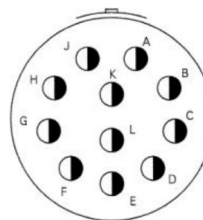
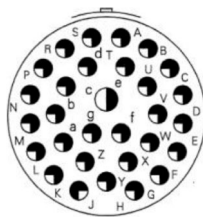
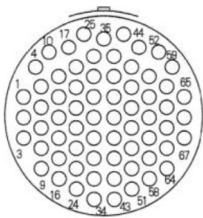
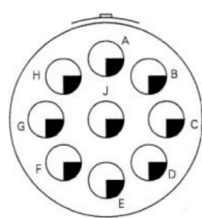
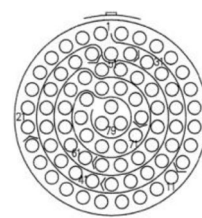
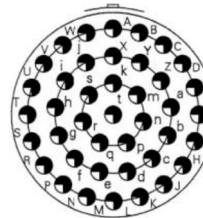
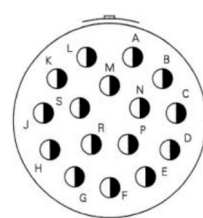
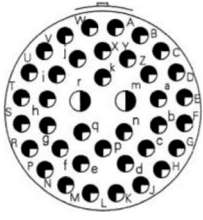
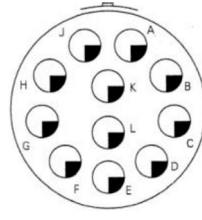
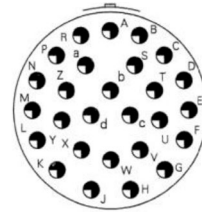
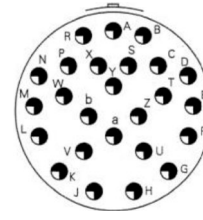
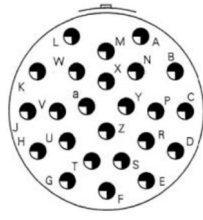
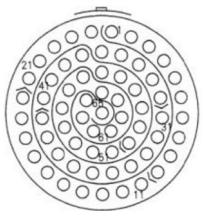
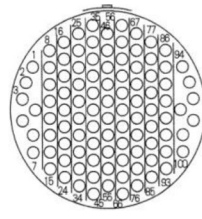
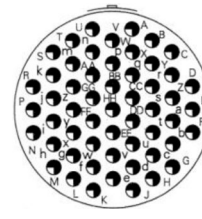
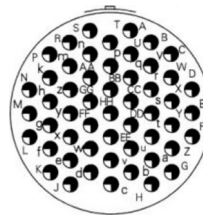
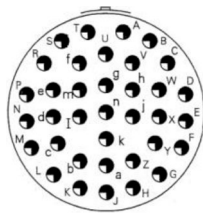
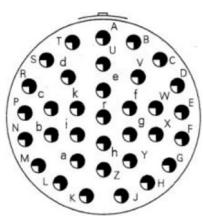
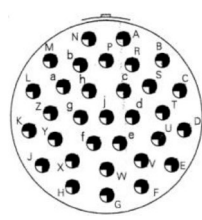
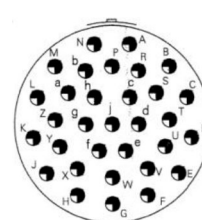
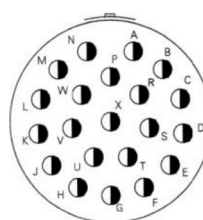
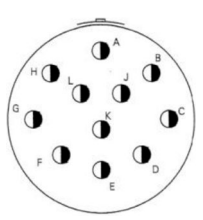

 <p>17-99 I</p>	 <p>17-05 II</p>	 <p>17-21</p>	 <p>17-30 N</p>	 <p>17-42 M</p>
 <p>19-35 M</p>	 <p>19-32 I</p>	 <p>19-28 I</p>	 <p>19-11 II</p>	 <p>19-30 I</p>
 <p>19-45 M</p>	 <p>19-96 I</p>	 <p>21-35 M</p>	 <p>21-41 I</p>	 <p>21-16 II</p>
 <p>21-39 I</p>	 <p>21-11 II</p>	 <p>21-27 I</p>	 <p>21-25 I</p>	 <p>21-24 I</p>
 <p>21-02 M</p>	 <p>23-35 M</p>	 <p>23-55 I</p>	 <p>23-53 I</p>	 <p>23-36 I</p>
 <p>23-34 I</p>	 <p>23-32 I</p>	 <p>23-21 II</p>	 <p>23-97 I</p>	 <p>23-99 II</p>

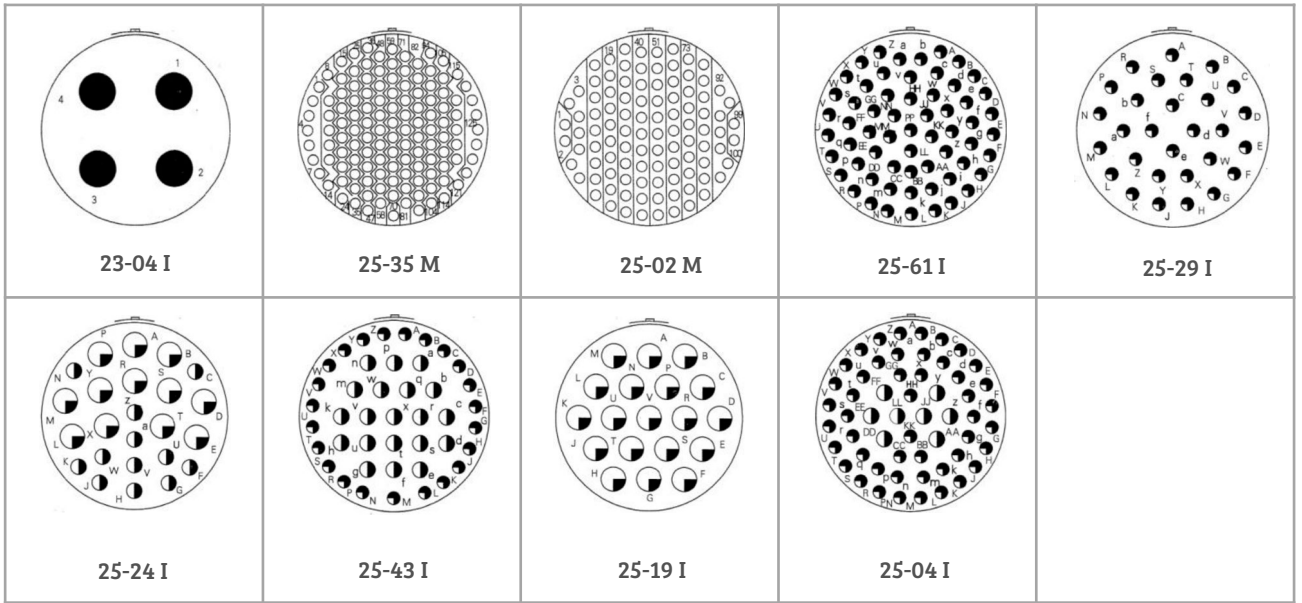

Orientation

Receptacle

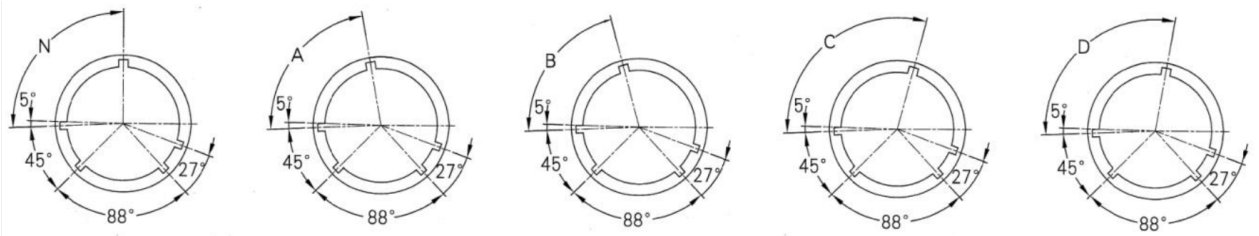

Plug

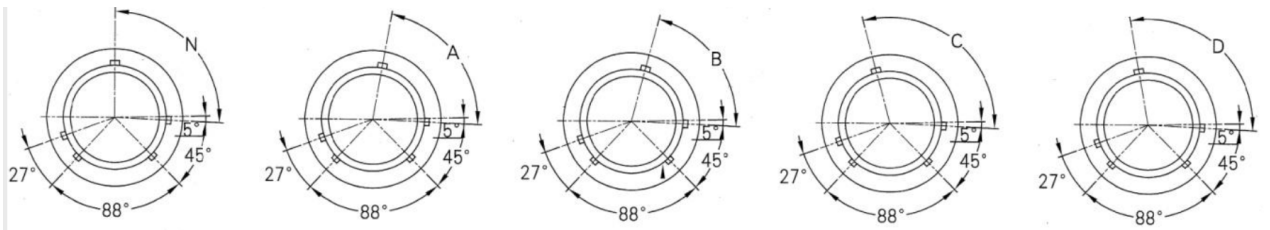

Orientation ID	09	11	13	15	17	19	21	23	25
N	95°	95°	95°	95°	95°	95°	95°	95°	95°
A	77°	81°	75°	74°	77°	77°	77°	80°	80°
B	-	67°	63°	61°	65°	65°	65°	69°	69°
C	-	123°	127°	129°	125°	125°	125°	121°	121°
D	113°	109°	115°	116°	113°	113°	113°	110°	110°

Shell size

Straight plug (RF27467)

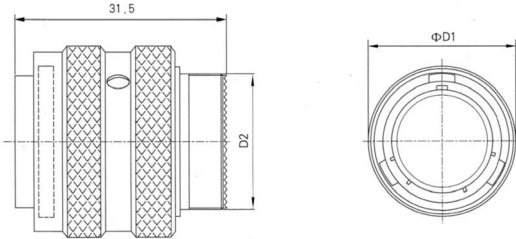

Shell No.	D1	Thread D UNEF-2A
9	21.7	0.4375-28
11	25.0	0.5625-24
13	28.2	0.6825-24
15	31.3	0.8125-20
17	34.4	0.9375-20
19	37.4	1.0625-18
21	40.5	1.1875-18
23	44.0	1.3125-18
25	46.8	1.4375-18

Jam nut receptacle (RF27468)

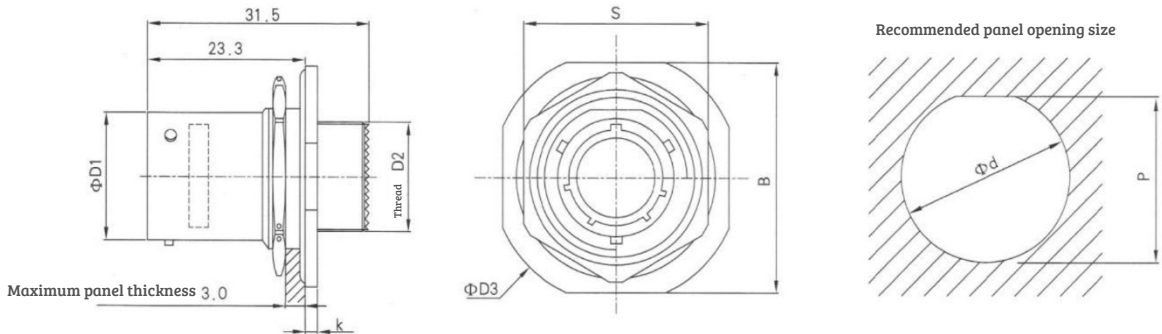

Shell No.	D1	Thread D2 UNEF-2A	D3	K	B	S	d	p
9	21.7	0.4375-28	30.2	2.4	27.0	22.3	17.7	17.0
11	25.0	0.5625-24	35.0	2.4	31.8	25.5	21.0	19.6
13	28.2	0.6825-24	38.1	2.8	35.0	30.2	25.6	24.3
15	31.3	0.8125-20	41.3	2.8	38.1	33.4	28.8	27.6
17	34.4	0.9375-20	44.5	2.8	41.3	36.6	32.0	30.7
19	37.4	1.0625-18	49.3	3.6	46.0	39.7	35.2	33.9
21	40.5	1.1875-18	52.4	3.6	49.2	42.9	38.3	37.1
23	44.0	1.3125-18	55.6	3.6	52.4	46.1	41.5	40.0
25	46.8	1.4375-18	58.8	3.6	55.6	50.8	44.7	43.4

Wall mounting square receptacle, front (RF27466)

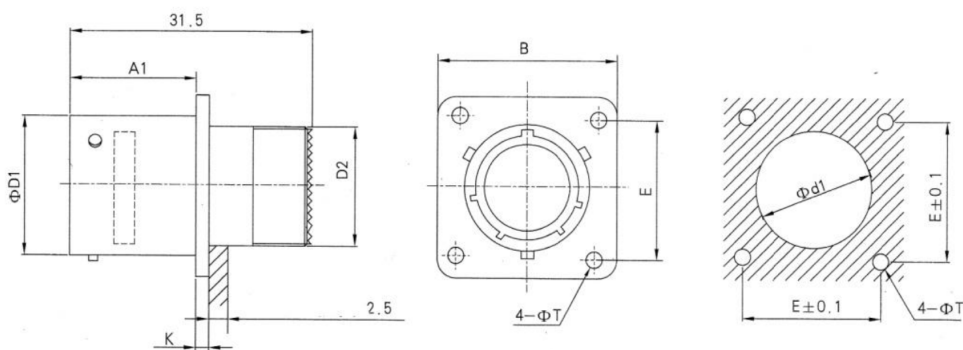

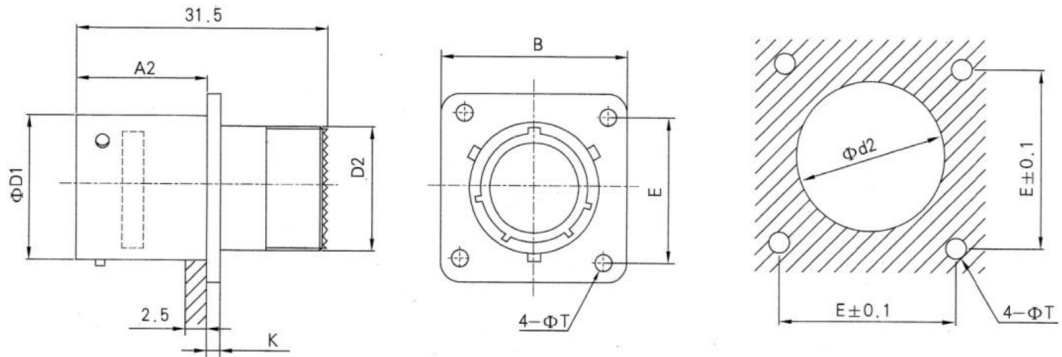
Wall mounting square receptacle, rear (RF27656)

Shell No.	D1	Thread D2 UNEF-2A	A1	A2	k	B	E	T	d1	d2
9	14.6	0.4375-28	16.1	20.9	2.4	23.8	18.26	3.2	12.5	16.7
11	17.8	0.5625-24	16.1	20.9	2.4	26.2	20.62	3.2	15.5	20.2
13	21.6	0.6825-24	16.1	20.9	2.4	28.6	23.02	3.2	19.5	24.5
15	24.8	0.8125-20	16.1	20.9	2.4	31.0	24.62	3.2	21.5	27.7
17	28.0	0.9375-20	16.1	20.9	2.4	33.3	26.98	3.2	25.0	30.9
19	30.7	1.0625-18	16.1	20.9	2.4	36.5	29.36	3.2	28.0	32.9
21	33.8	1.1875-18	15.3	20.1	3.1	39.7	31.76	3.2	31.5	36.2
23	37.0	1.3125-18	15.3	20.1	3.1	42.9	34.92	3.7	34.5	39.3
25	40.2	1.4375-18	15.3	20.1	3.1	46.0	38.10	3.7	37.5	42.5

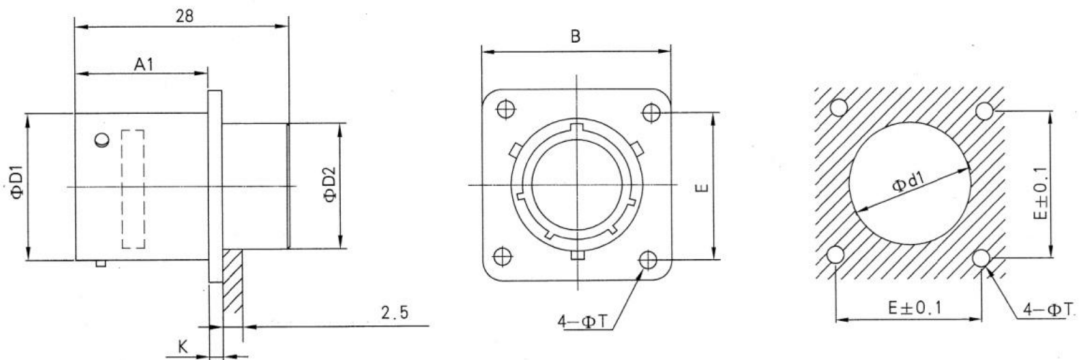
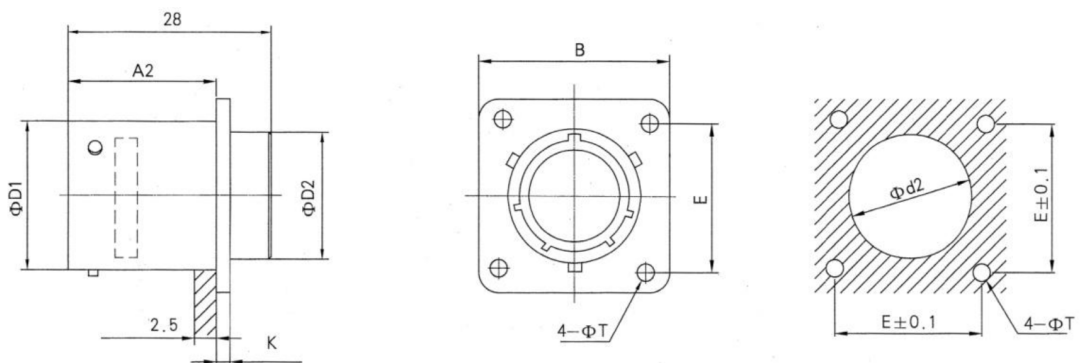
Box square receptacle, front (RF27496)

Box square receptacle, rear (RF27505)

Shell No.	D1	D2	A1	A2	k	B	E	T	d1	d2
9	14.6	11.2	16.1	20.9	2.4	23.8	18.26	3.2	12.5	16.7
11	17.8	14.5	16.1	20.9	2.4	26.2	20.62	3.2	15.5	20.2
13	21.6	18.0	16.1	20.9	2.4	28.6	23.02	3.2	19.5	24.5
15	24.8	20.5	16.1	20.9	2.4	31.0	24.62	3.2	21.5	27.7
17	28.0	23.8	16.1	20.9	2.4	33.3	26.98	3.2	25.0	30.9
19	30.7	26.5	16.1	20.9	2.4	36.5	29.36	3.2	28.0	32.9
21	33.8	29.7	15.3	20.1	3.1	39.7	31.76	3.2	31.5	36.2
23	37.0	32.8	15.3	20.1	3.1	42.9	34.92	3.7	34.5	39.3
25	40.2	36.0	15.3	20.1	3.1	46.0	38.10	3.7	37.5	42.5

Receptacle with PCB contact

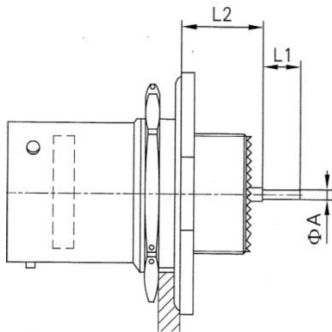
Receptacle (RF27468)



Receptacle (RF27468)

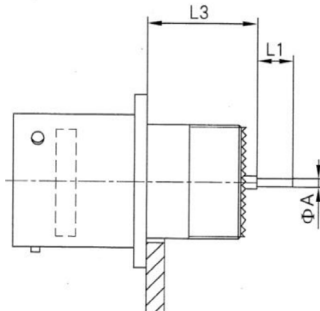

Receptacle (RF27656)

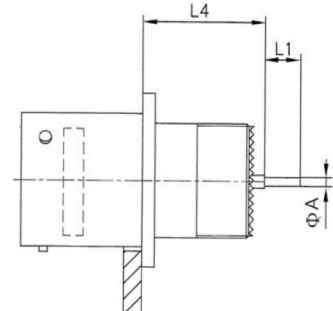

Contact type for PCB		L1	A
22D*	Long contact for PCB	8.5	0.7
	Short contact for PCB	4.0	
20*	Long contact for PCB	8.5	0.7
	Short contact for PCB	5.0	
16*	Long contact for PCB	8.5	1.15
	Short contact for PCB	5.0	

Size for contact			Shell No.	Shell No.
			09, 11, 13, 15, 17, 19	21, 23, 25
L2	Male pin for 22D*	max	10.06	10.06
		min	9.06	9.06
	Female pin for 22D*	max	10.06	10.06
		min	8.74	8.74
	Pin for 20* And 16*	max	10.23	10.23
		min	9.24	9.24
L3	Male pin for 22D*	max	15.08	15.08
		min	13.91	13.91
	Female pin for 22D*	max	15.08	15.08
		min	13.58	13.58
	Pin for 20* And 16*	max	15.25	15.25
		min	14.08	14.08
L4	Male pin for 22D*	max	12.47	13.22
		min	11.60	12.35
	Female pin for 22D*	max	12.47	13.22
		min	11.27	12.02
	Pin for 20* And 16*	max	12.64	13.99
		min	11.77	12.52